

Tous droits strictement réservés. Reproduction ou communication à des tiers interdite sous quelque forme que ce soit sans autorisation écrite du propriétaire. Propriété de c FCI. Droits de reproduction FCI.

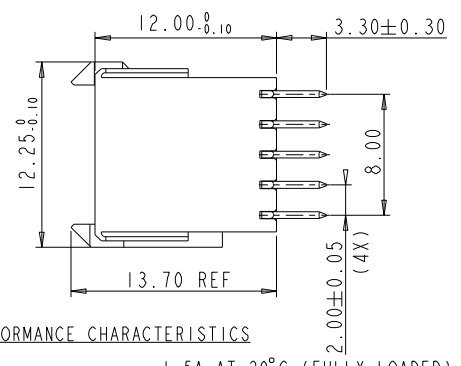

FCI

All rights strictly reserved. Reproduction or issue to third parties in any form whatever is not permitted without written authority from the proprietor. Property of FCI. Copyright FCI.

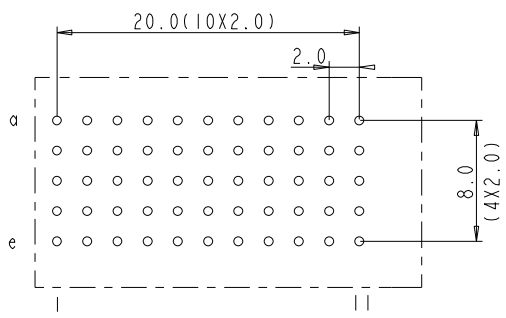
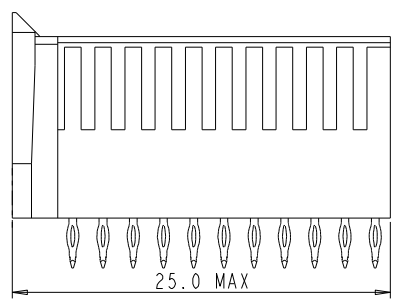
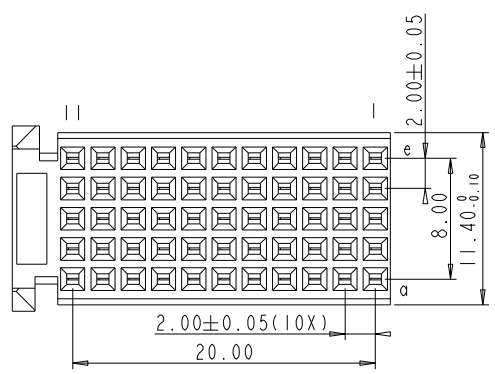

PERFORMANCE CHARACTERISTICS

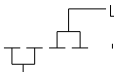
- CURRENT RATING : 1.5A AT 20°C (FULLY LOADED)
- CURRENT RATING : 1 A AT 70°C (FULLY LOADED)
- RATED VOLTAGE : 500 V AC (CONT /CONT)
- OPERATING TEMPERATURE : -55°C TO 125°C
- CONTACT RESISTANCE 20 MΩ MAX
- INSERTION FORCE : 0.75N MAX/CONT
- EXTRACTION FORCE : 0.15N MIN/CONT
- INSULATION RESISTANCE : 10⁴ MΩ MIN

- NOTES**
1. "  " LEAD FREE INDICATOR :LF=LEAD FREE
 PERFORMANCE LEVEL INDICATOR (REF DWG NO.BSC .201844.003)
 2. THIS PRODUCT IS CSA APPROVED.
THIS PRODUCT IS UL RECOGNIZED.
 3. FOR RECOMMENDED PTH DIMENSIONS REFER DRAWING :BS.A.201572.001
 4. THIS PRODUCT (LF) MEETS EUROPEAN UNION DIRECTIVES AND OTHER COUNTRY REGULATIONS AS DESCRIBED IN GS-22-008

rev	ecn no	dr	date
A	CONVERSION REVISION 00	KN	14-09-01
B	104-0114	Al'ex B	27.11.04
C	DG05-0278	Kason	02-08-05
-	-	-	-
-	-	-	-
-	-	-	-
-	-	-	-

Material		Spec ref	
Mat code		tolerance	projection
Heatreat		IDECC=0,2 IDEC 2DEC=0,1 2DEC ANGLESET* HOEKEN	
Plating/Finish		Dr	MM
Dr	M.Pret	31-10-97	size A4
Eng			Scale 2.000
Chr			Product family MILLIPACS
Appr			Model Name
			Model Revision
			ECN DG05-0278
			REL Level
FCI	title	MILLIPACS 2/TYPE C(W/O LOC.PEG) / NO SHIELDING	Rev. C
Pro/E file	catalog	HM2S30PE5100	dwg no BSC201907008
		PDM: Rev.C	STATUS: Released
			Printed: Sep 30, 2005